

# Circuito Retificador

Prof. Nilton Cesar de O  
Borges

# Fontes CC



# Fontes CC



# Fontes CC



For E746



For V8K10



For V3



For KGP0



For V8



For 6101



# Fontes CC



For E746



For V8K3D



For V3



For KGP0



For V8



For 6101



Fonte CC tem como característica principal fornecer uma **tensão de valor constante**.

✓ Não necessitam de energia de alimentação, pilha e bateria

✓ Necessitam de alimentação de uma rede elétrica, carregador de celular, fonte de computador, fonte interna de uma tv etc

Fonte CC, que necessitam de alimentação de uma rede elétrica.

- As fontes CC dessa natureza possuem basicamente as etapas de:
  - Retificação
  - Filtragem
  - Regulação

# Circuitos Retificadores

A função do circuitos retificadores é transformar tensão alternada, fornecida pelas concessionárias.

Em uma tensão de **única polaridade**, porém ainda de valor variável.



# Tensão alternada

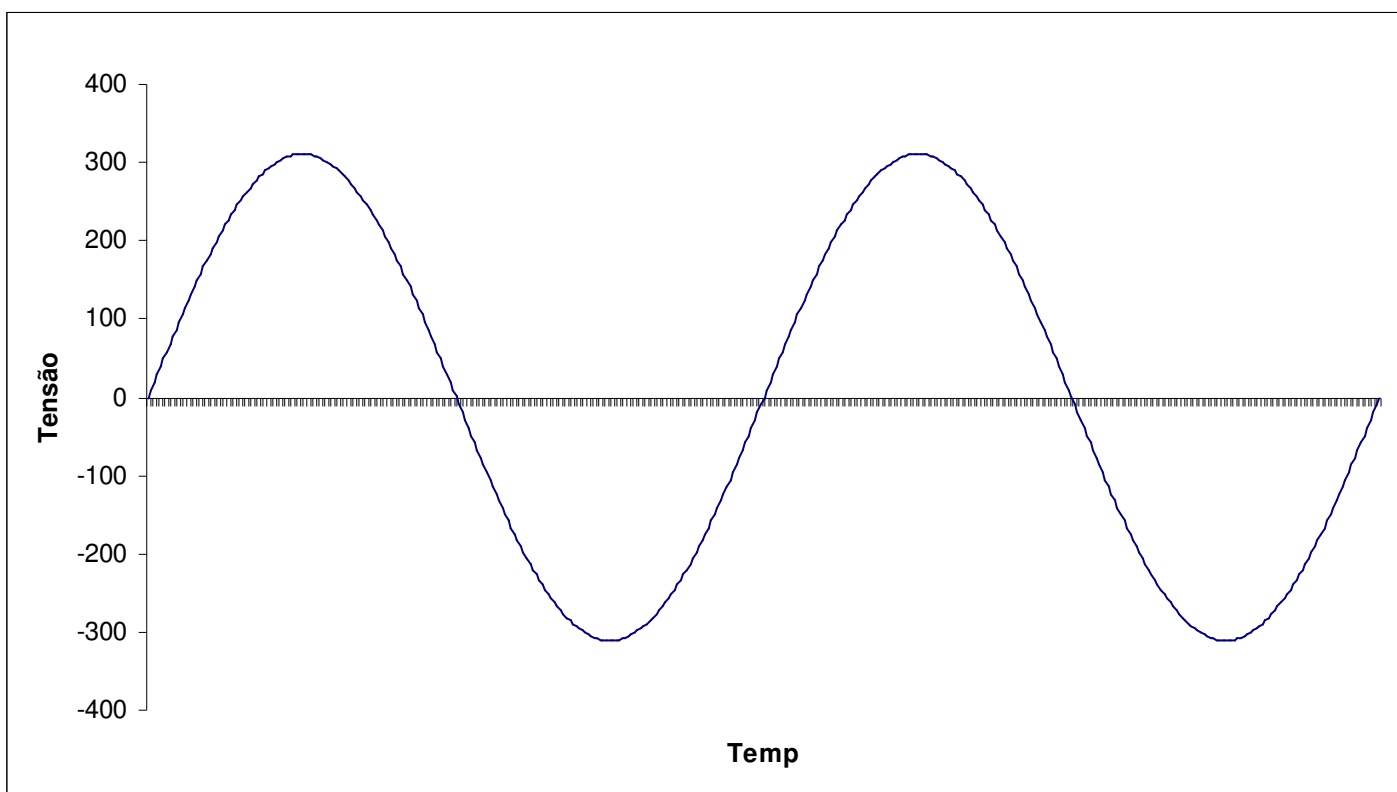

# Retificação de meia onda

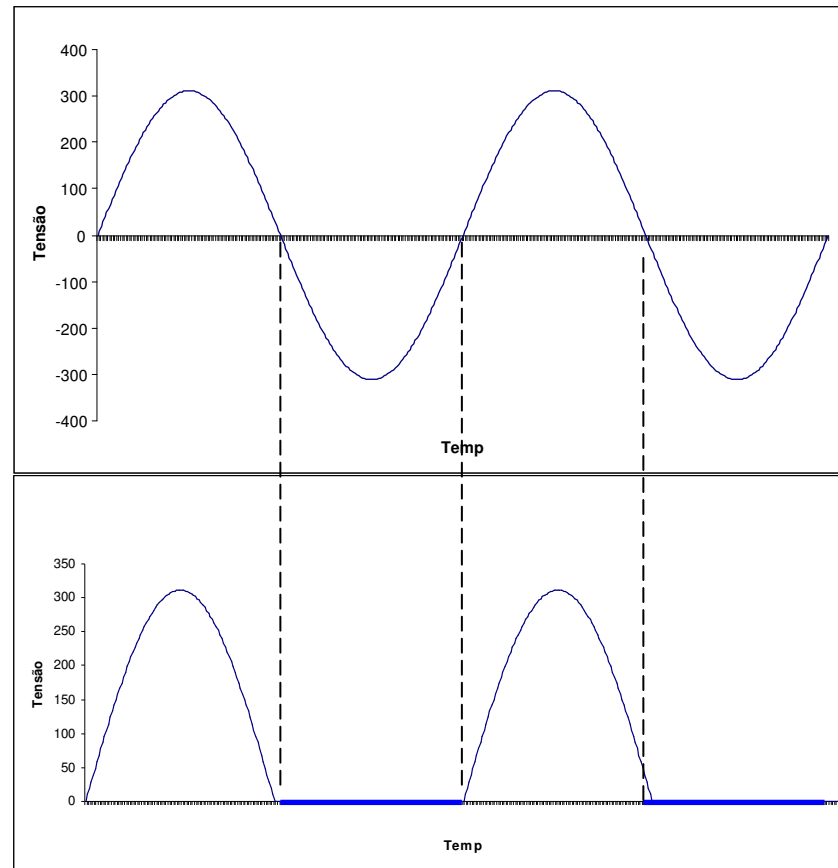

← Entrada

← Saída

# Retificação Onda completa

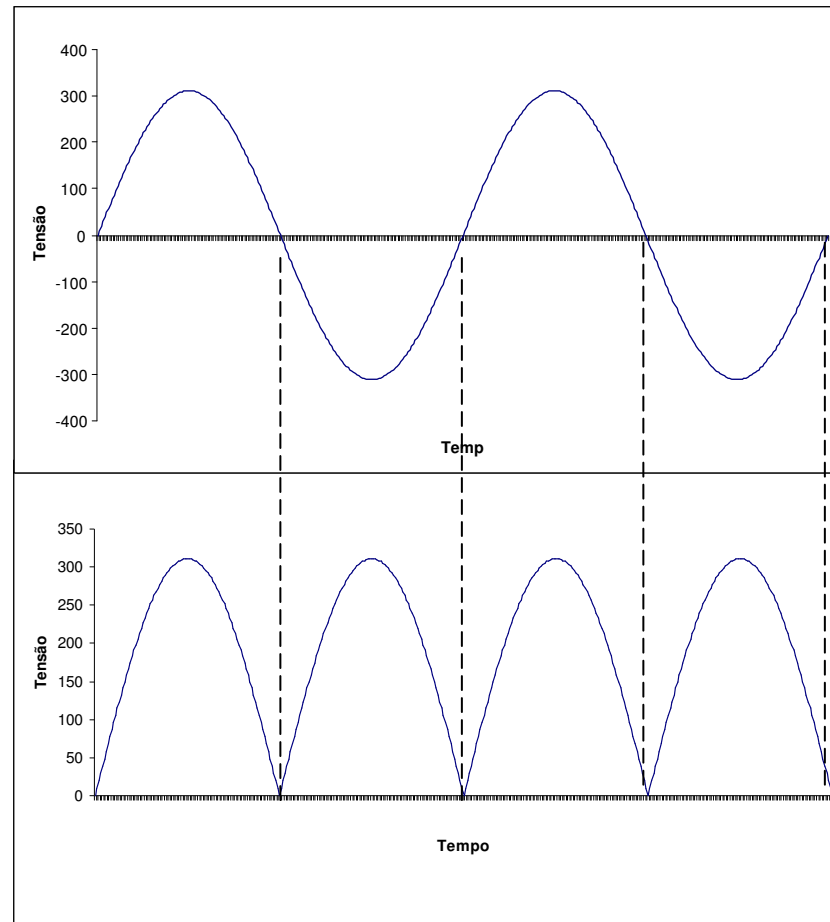

← Entrada

← Saída

# Diodo

Conduz corrente em um único sentido

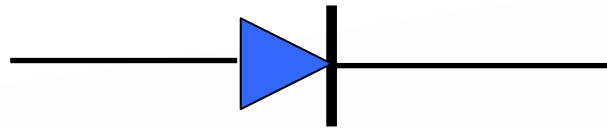

Tensione

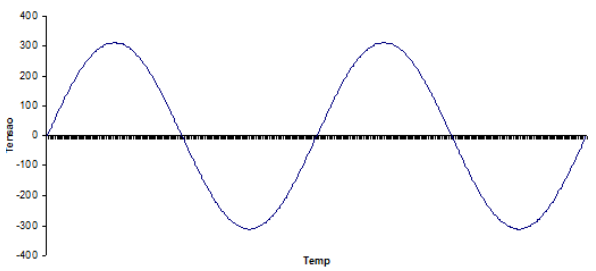

Temp

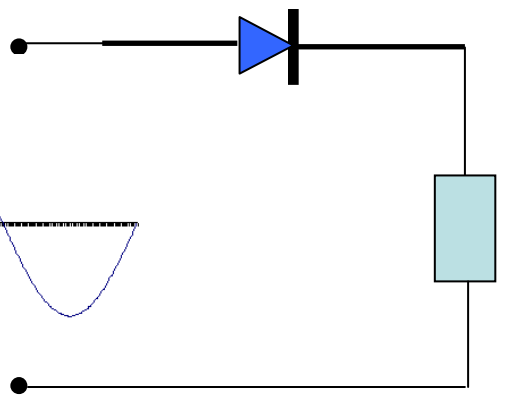

Carga

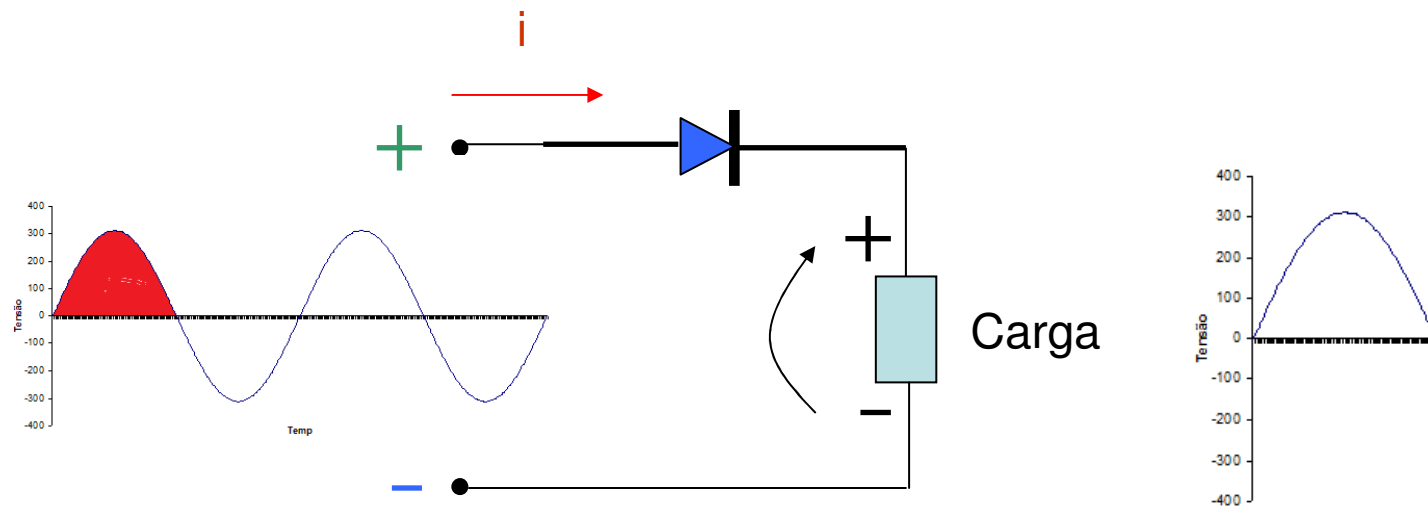

O diodo conduz e a tensão da entrada passa para a saída

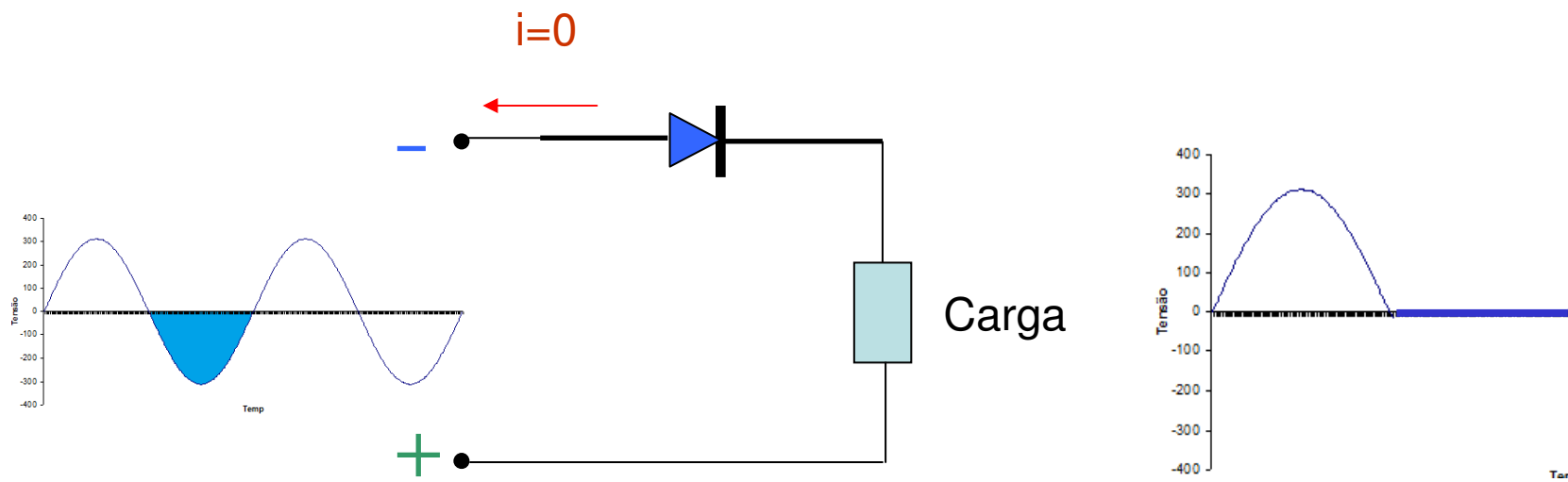

O diodo **não conduz** e a tensão da entrada **não passa** para a saída

# Retificador de meia onda

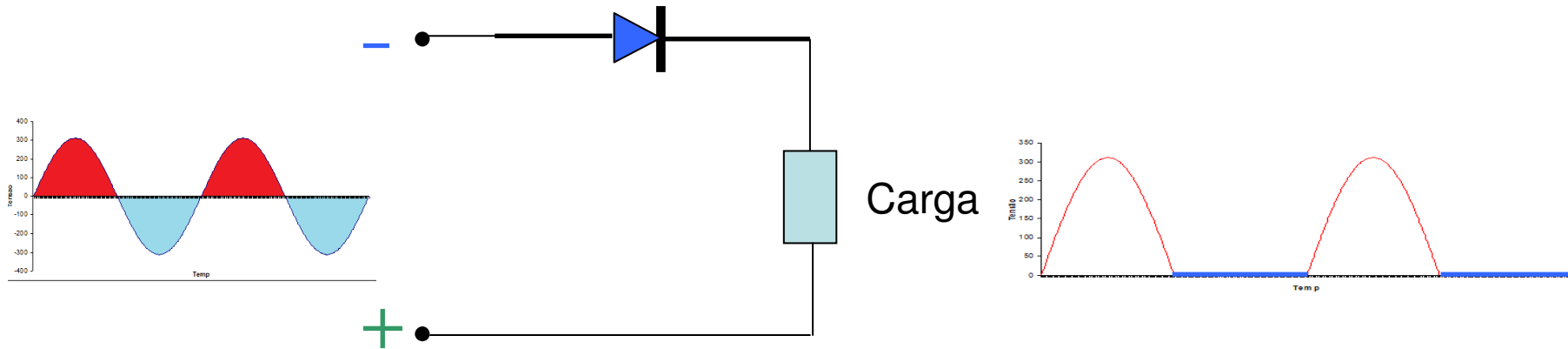



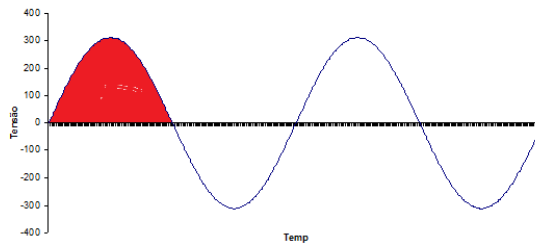
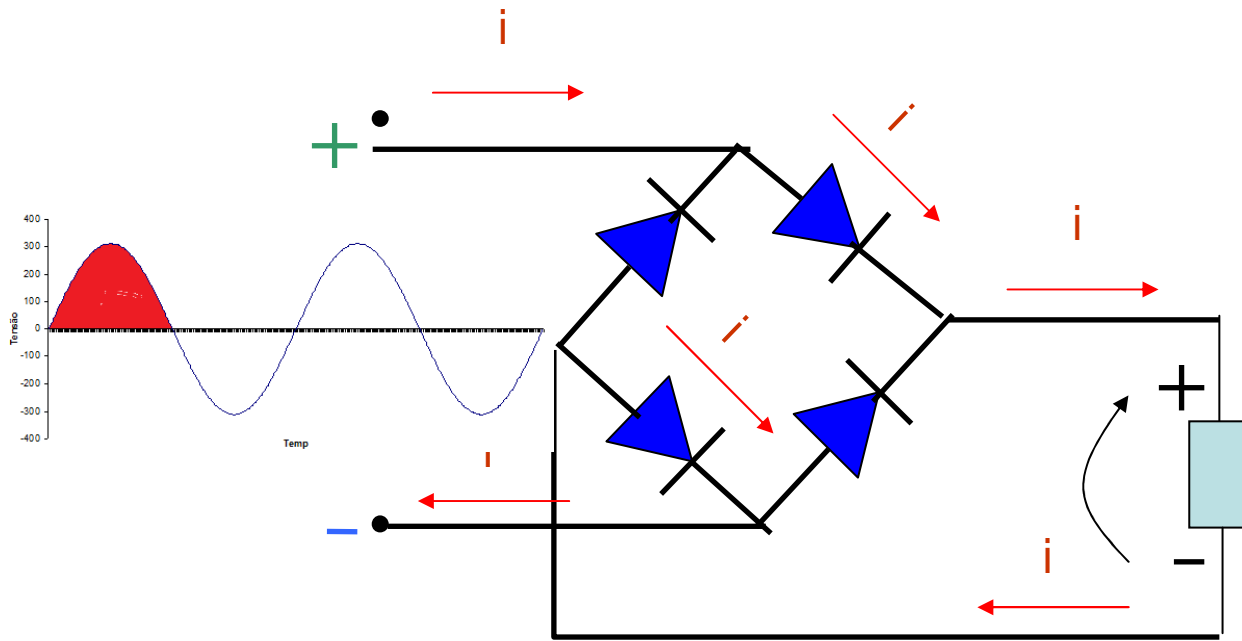

Carga

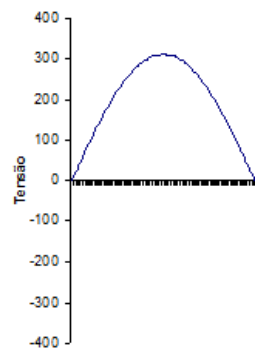

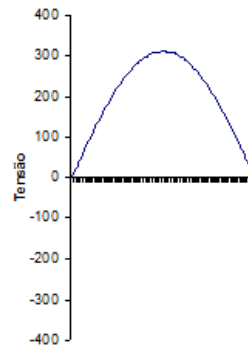
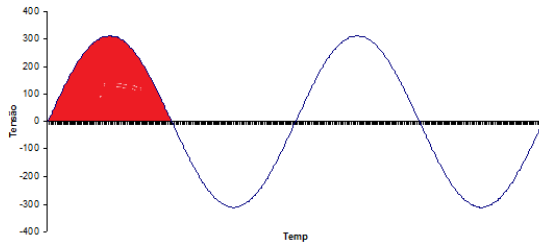
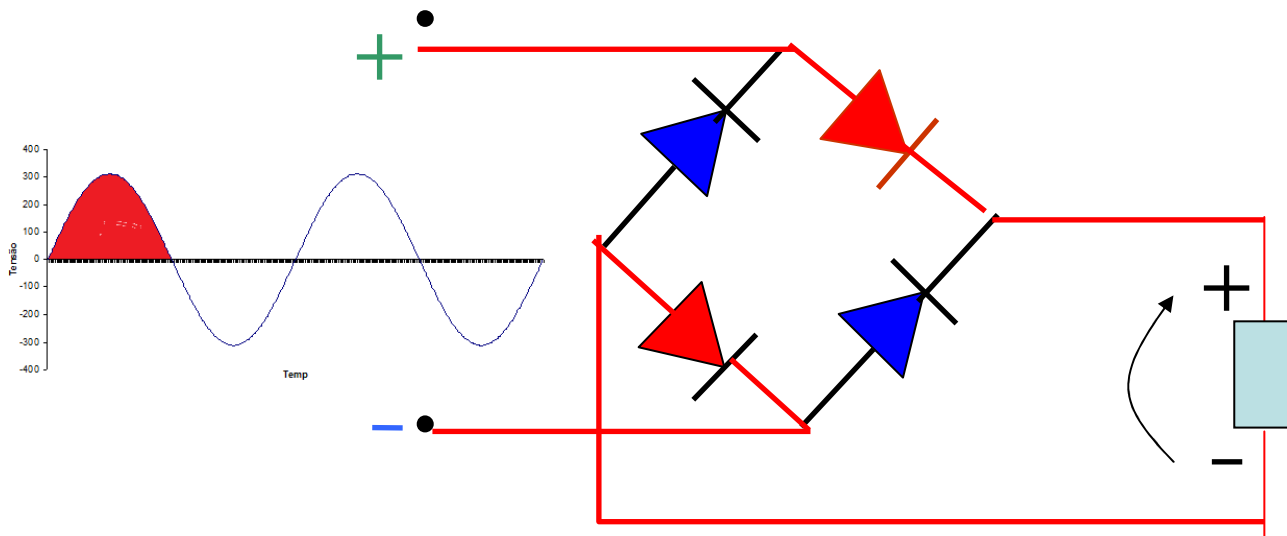

Carga

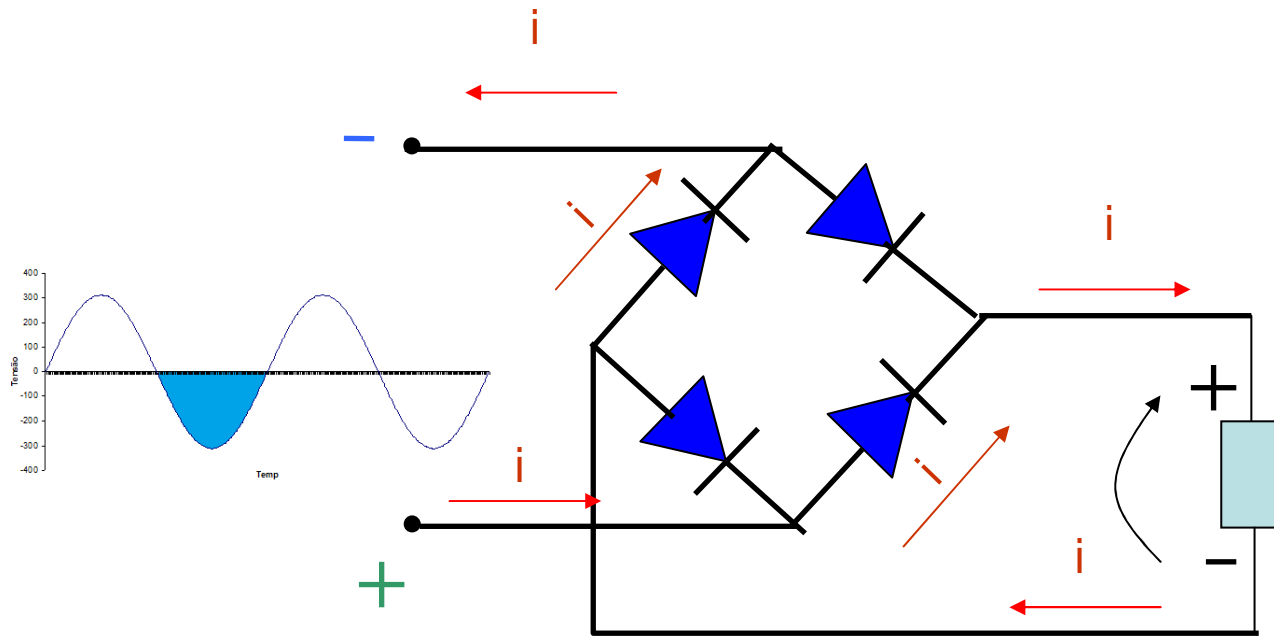

Carga

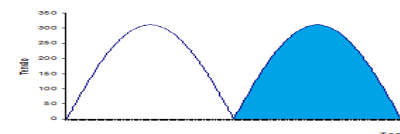

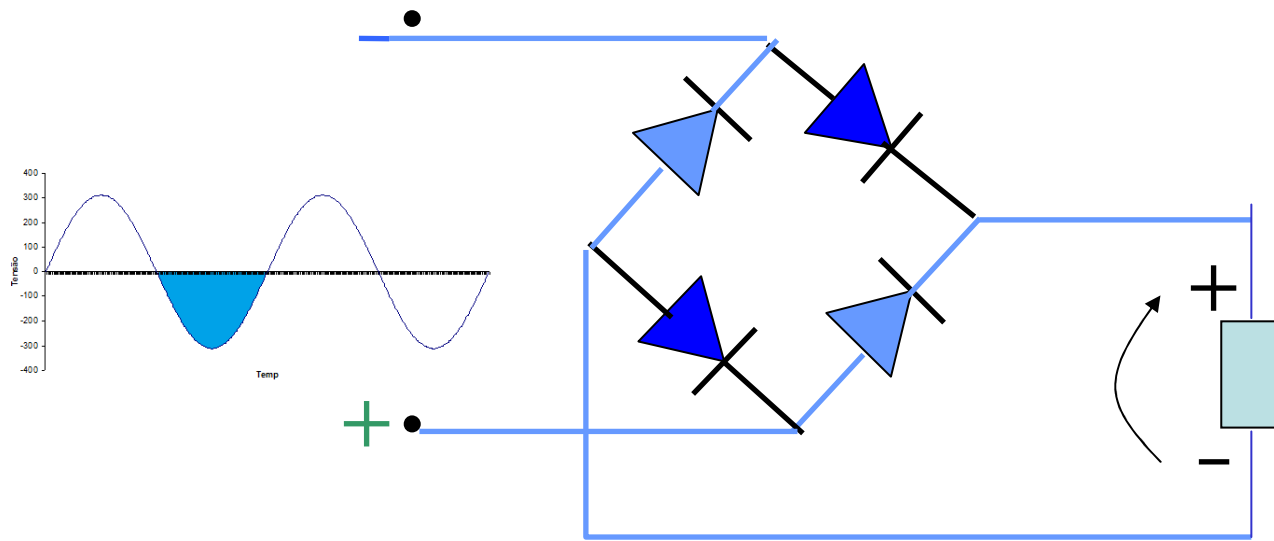

Carga

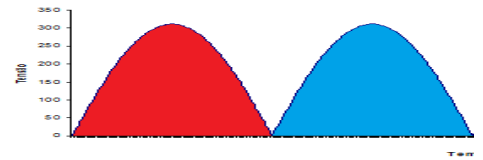

# Ponte retificadora de onda completa integrada

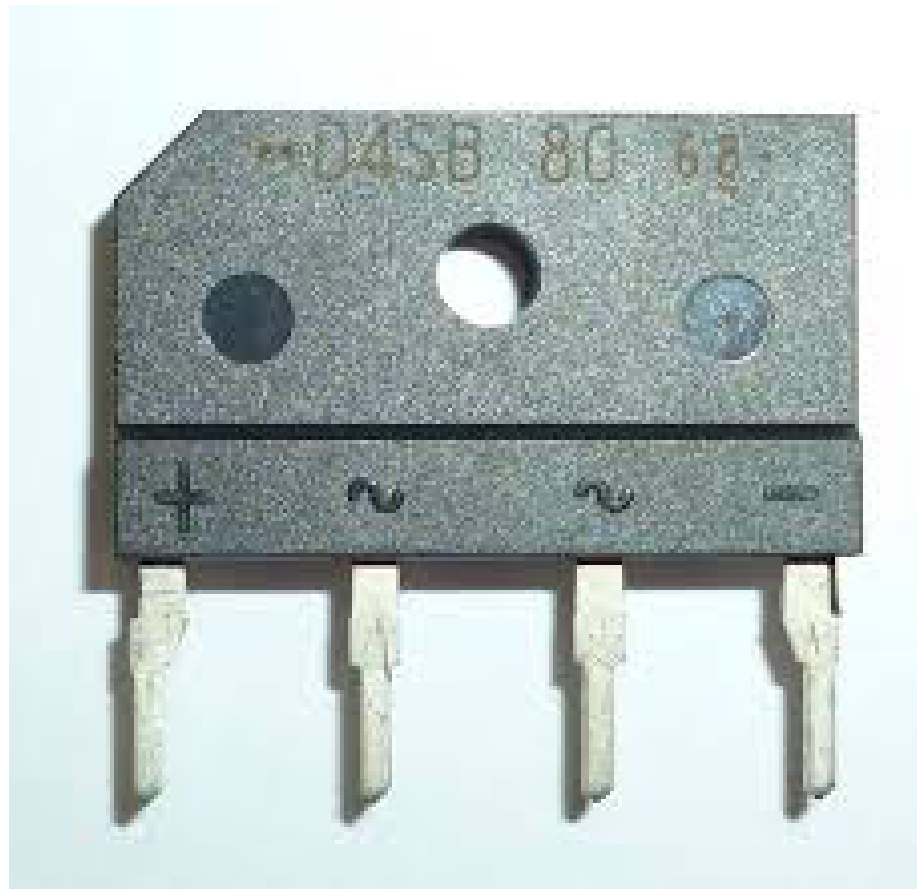

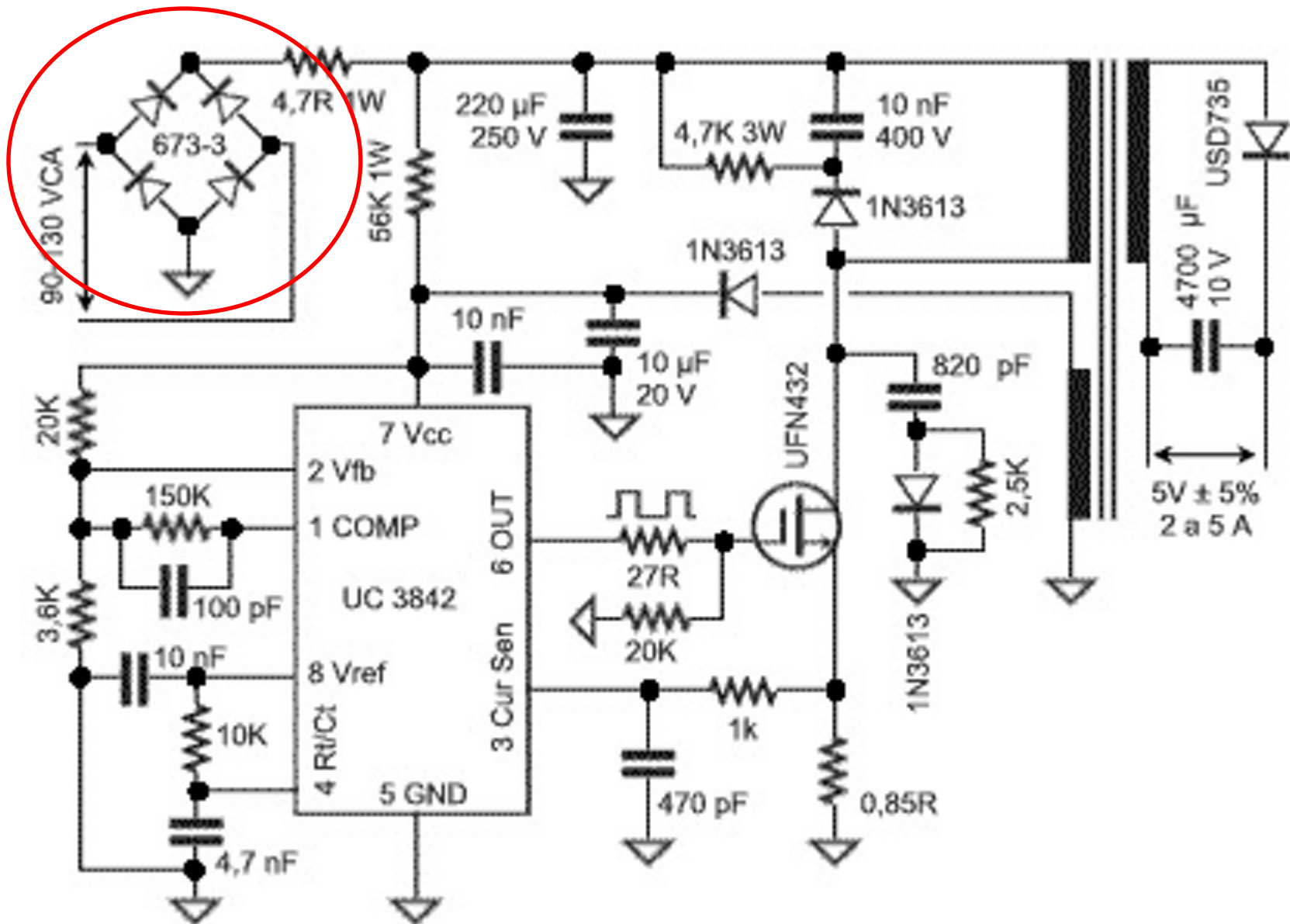

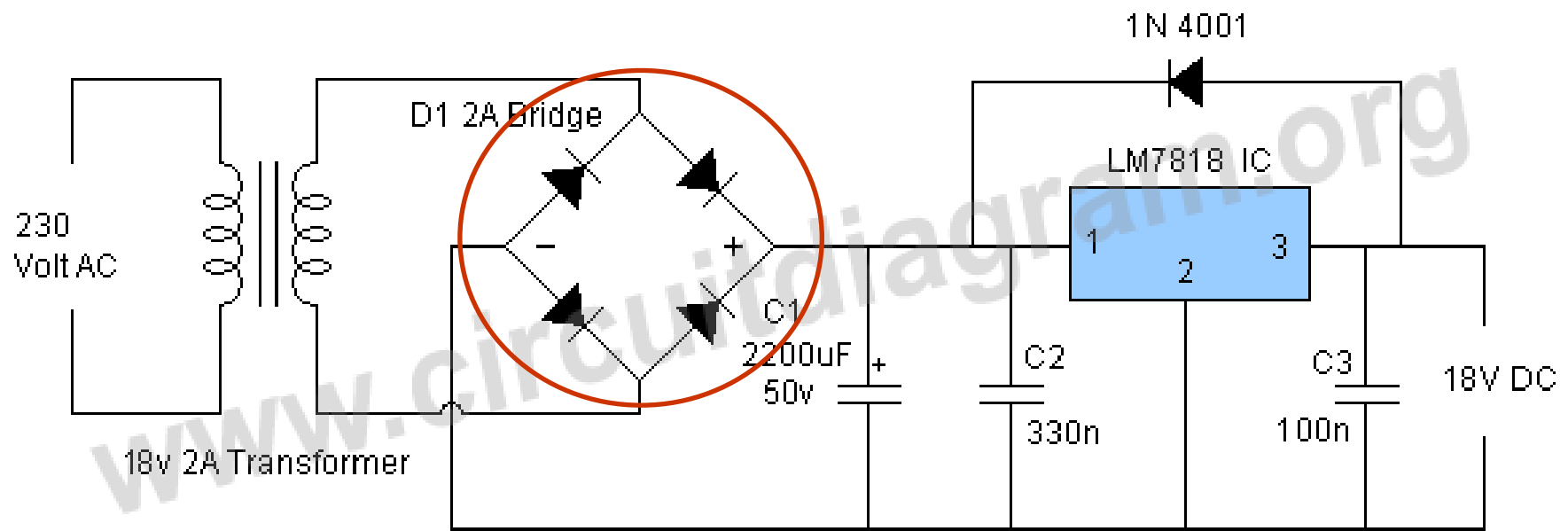

# Exemplos de esquema utilizados em fontes atuais

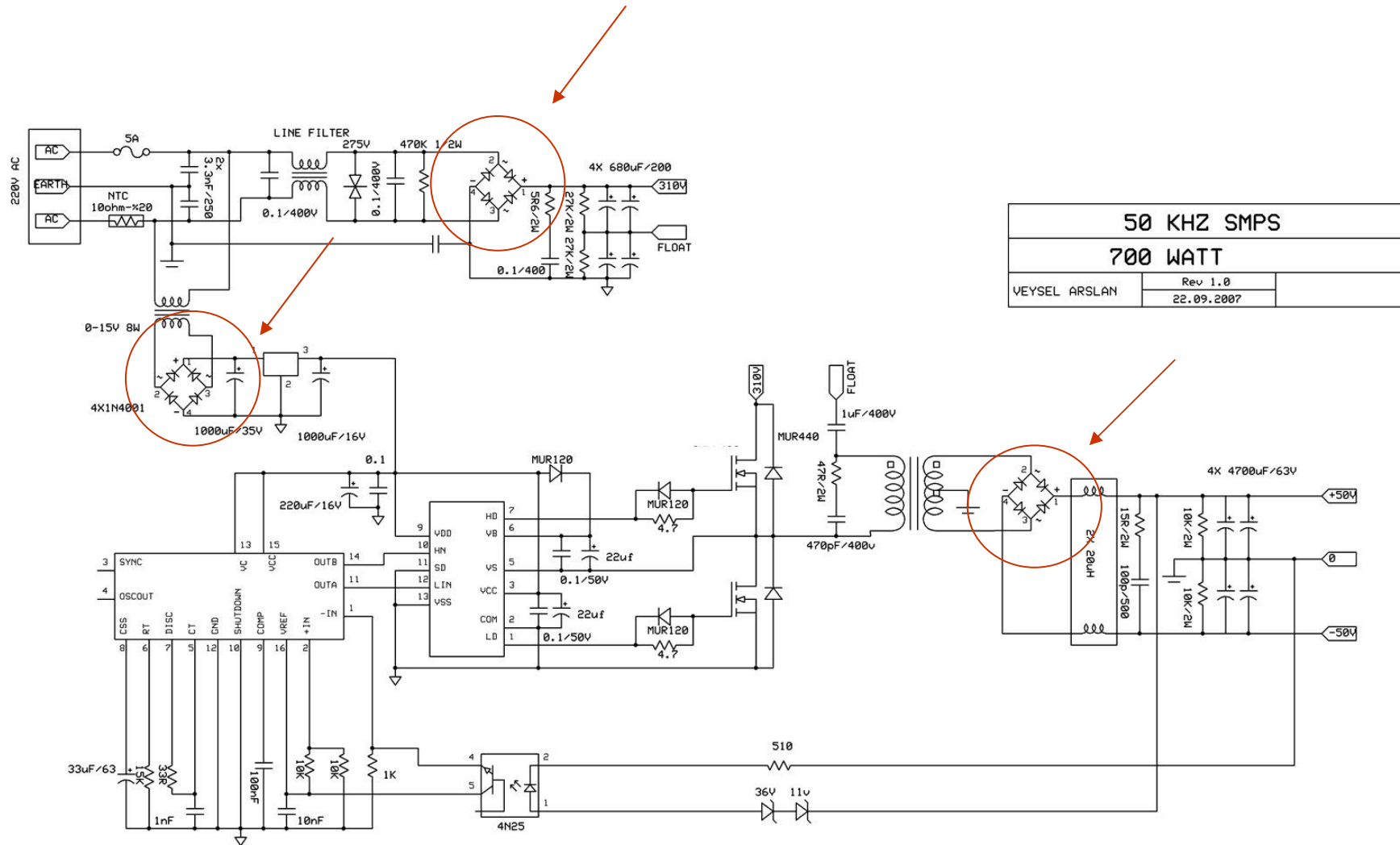

<b>50 KHZ SMPS</b>	
<b>700 WATT</b>	
VEYSEL ARSLAN	Rev 1.0
	22.09.2007



- Obrigado a Todos